



# SOFA

ESTABLISHMENT



This inspirational range of recliners captures the essence of form and function, and is a practical and elegant solution for the home theatre, media room or your own private lounge room.

Its modular design system with interconnecting seats and arms allows you to stretch your imagination to maximise and customise the use of space and seating capacity.

The one touch control operates the electrically powered mechanism from the upright and fully reclined positions – and all points in between.

The absence of old fashioned pillow style cushions accentuates the clean, modern lines of this range of contemporary recliners.

The chairs also feature a removable chaise pad and can be made in the fabric or leather of your choice.

Proudly made in Australia and guaranteed for ten years.

## Stretch

Designed by Enrique Ferreira, Sydney, Australia

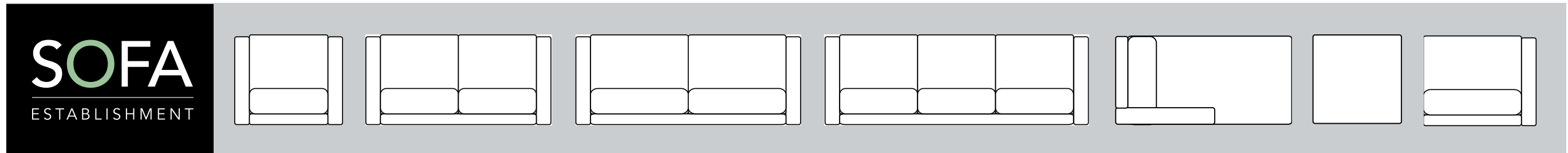

# Stretch

## Product guide

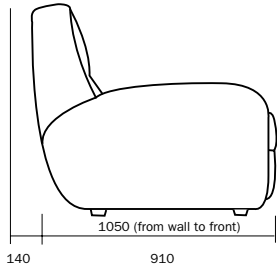
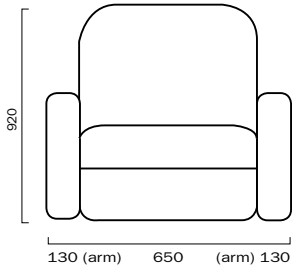

**NOTE:** If you choose a wedge component you will need to add an additional 130mm to the rear length measurement, eg, for a chair with one arm and one wedge, the front L-to-R measurement is 910mm, while L-to-R at rear measures 1040mm.

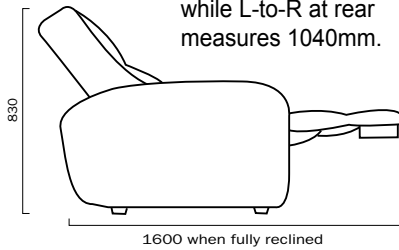
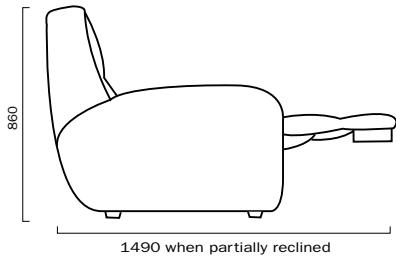

The Stretch recliner series is specially designed to provide maximum comfort in both home theatre/ cinema environments and in small to medium scale commercial media rooms, where the emphasis is on design excellence and premier viewing experiences.

Be persuaded by the soft, luxurious, welcoming feel of Stretch, safe in the knowledge that these recliners are ergonomically correct and constructed from quality materials to ensure durability.

The absence of loose cushions affords them a certain elegance, making them easy on the eye and

also ensuring maintenance and cleaning is a breeze.

Mix and match component parts to suit your space and application. Units can be left as individual components or be locked together in either straight or curved formations to maximise viewing angles.

While Sofa Establishment specialises in leather, this range can be made in a fabric of your choice.

Proudly made in Australia and guaranteed for ten years.

## Components

Note: Drink holders by request. Triangle wedge arms also available

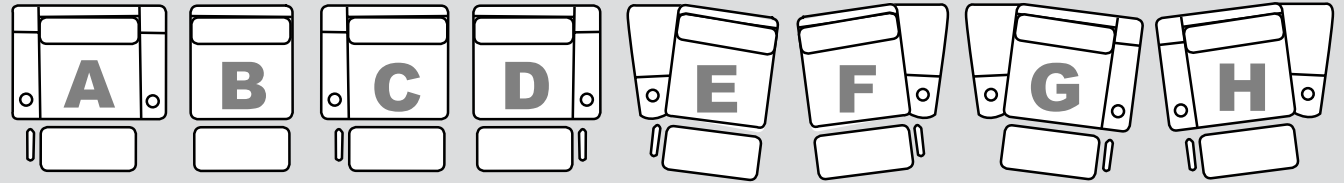

## Endless variations....

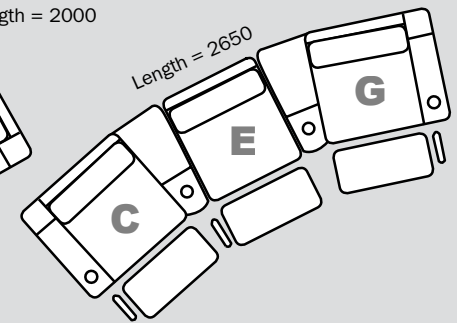
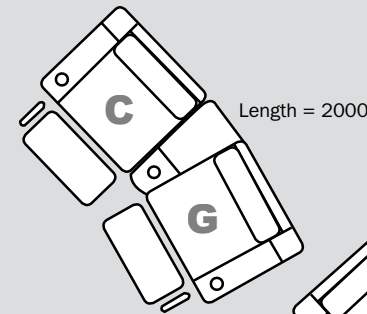
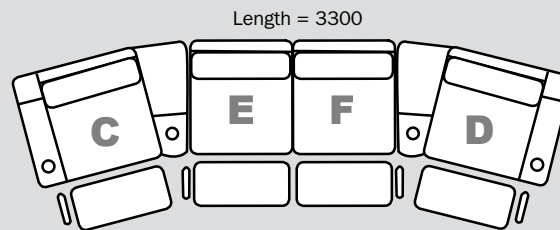
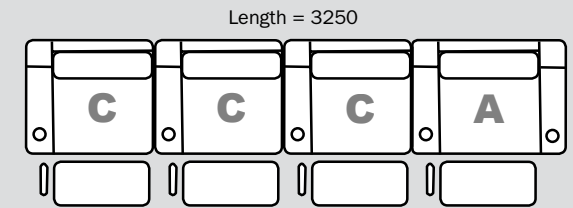
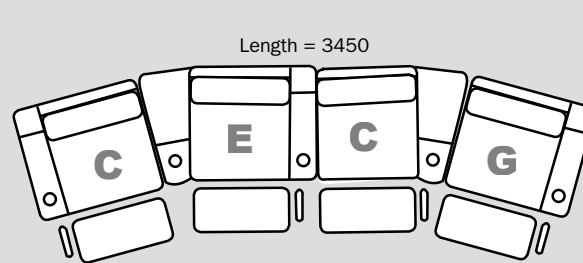

**SOFA**  
ESTABLISHMENT

74A Belmore Road (North), Riverwood NSW 2210

[www.sofaestablishment.com.au](http://www.sofaestablishment.com.au)

p +61 (0)2 9533 5378 | m +61 (0)408 998 398 | e [info@sofaestablishment.com.au](mailto:info@sofaestablishment.com.au)